



Hettich

Sliding and folding door systems for cabinetry applications.

Edition 1



TopLine XL: Puristic design of large fronts.
Experience unequalled user convenience

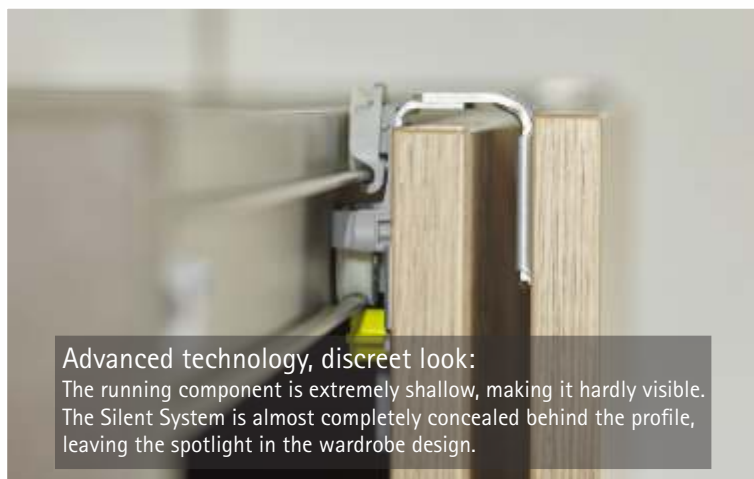

Advanced technology, discreet look:
The running component is extremely shallow, making it hardly visible. The Silent System is almost completely concealed behind the profile, leaving the spotlight in the wardrobe design.

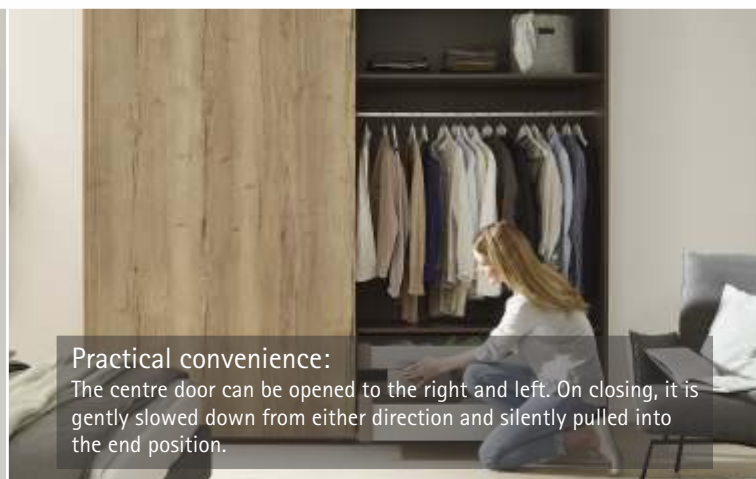

Practical convenience:
The centre door can be opened to the right and left. On closing, it is gently slowed down from either direction and silently pulled into the end position.



Smooth, quiet running action:
The rollers continue to move in virtual silence even after prolonged periods out of use.



Impressive user convenience:
Very low opening forces mean that the doors are easily opened with a mere stroke of the hand. The new generation Silent System then slows the doors down particularly gently.

Door Weight Calculation Table

Values are for 19mm door thickness and 0.70 density (e.g MDF)

Door Size (mm)	200	250	300	350	400	450	500	550	600	650	700	750	800
500	1.3	1.7	2.0	2.3	2.7	3.0	3.3	3.7	4.0	4.3	4.7	5.0	5.3
600	1.6	2.0	2.4	2.8	3.2	3.6	4.0	4.4	4.8	5.2	5.6	6.0	6.4
700	1.9	2.3	2.8	3.3	3.7	4.2	4.7	5.1	5.6	6.1	6.5	7.0	7.4
800	2.1	2.7	3.2	3.7	4.3	4.8	5.3	5.9	6.4	6.9	7.4	8.0	8.5
900	2.4	3.0	3.6	4.2	4.8	5.4	6.0	6.6	7.2	7.8	8.4	9.0	9.6
1000	2.7	3.3	4.0	4.7	5.3	6.0	6.7	7.3	8.0	8.6	9.3	10.0	10.6
1100	2.9	3.7	4.4	5.1	5.9	6.6	7.3	8.0	8.8	9.5	10.2	11.0	11.7
1200	3.2	4.0	4.8	5.6	6.4	7.2	8.0	8.8	9.6	10.4	11.2	12.0	12.8
1300	3.5	4.3	5.2	6.1	6.9	7.8	8.6	9.5	10.4	11.2	12.1	13.0	13.8
1400	3.7	4.7	5.6	6.5	7.4	8.4	9.3	10.2	11.2	12.1	13.0	14.0	14.9
1500	4.0	5.0	6.0	7.0	7.9	9.0	10.0	11.0	12.0	13.0	14.0	15.0	16.0
1600	4.3	5.3	6.4	7.4	8.4	9.6	10.6	11.7	12.8	13.8	14.9	16.0	17.0
1700	4.5	5.7	6.8	7.9	9.0	10.2	11.3	12.4	13.6	14.7	15.8	17.0	18.1
1800	4.8	6.0	7.2	8.4	9.6	10.8	12.0	13.2	14.4	15.6	16.8	18.0	19.2
1900	5.1	6.3	7.6	8.8	10.1	11.4	12.6	13.9	15.2	16.4	17.7	19.0	20.2
2000	5.3	6.7	8.0	9.3	10.6	12.0	13.3	14.6	16.0	17.3	18.6	20.0	21.3
2100	5.6	7.0	8.4	9.8	11.2	12.6	14.0	15.4	16.8	18.2	19.6	20.9	22.3
2200	5.9	7.3	8.8	10.2	11.7	13.2	14.6	16.1	17.6	19.0	20.5	21.9	23.4
2300	6.1	7.6	9.2	10.7	12.2	13.8	15.3	16.8	18.4	19.9	21.4	22.9	24.5
2400	6.4	8.0	9.6	11.2	12.8	14.4	16.0	17.6	19.2	20.7	22.3	23.9	25.5
2500	6.7	8.3	10.0	11.6	13.3	15.0	16.6	18.3	20.0	21.6	23.3	24.9	26.6
2600	6.9	8.6	10.4	12.1	13.8	15.6	17.3	19.0	20.7	22.5	24.2	25.9	27.7

Door weight = weight given in table x factor	
Door Thickness	Factor
15.0	0.79
16.0	0.84
18.0	0.95
19.0	1.00
20.0	1.05
22.0	1.16
23.0	1.21
26.0	1.37
29.0	1.53

Example	
Door width	: 500mm
Door Height	: 2000mm
Door Thickness	: 23mm
Hardwood	
Door weight	= Weight given in table x factor
	= 13.3kg x 1.21
	= 16.1kg

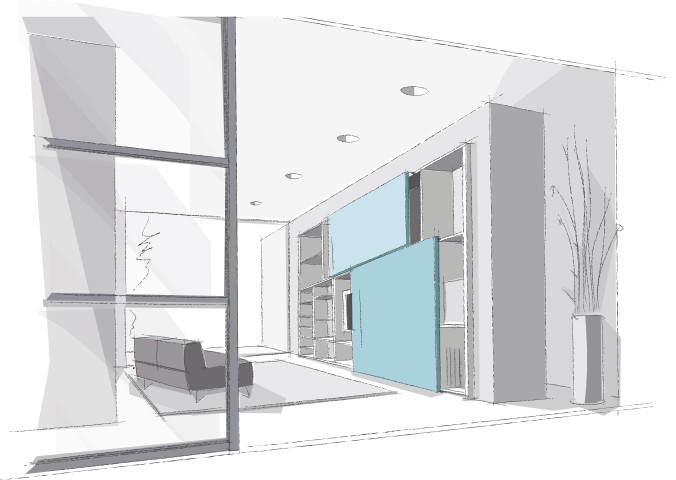

Design

Being creative with sliding doors

Sliding doors provide the key to picking up on modern, spacious interior design and continuing in furniture. Large surface doors open the way to purist interior design.

Modern sliding door systems create a look that impresses with narrow reveals that can also be kept to a minimum with large surface fronts. Easy precision adjustment provides superb finished results with perfect gap alignment.

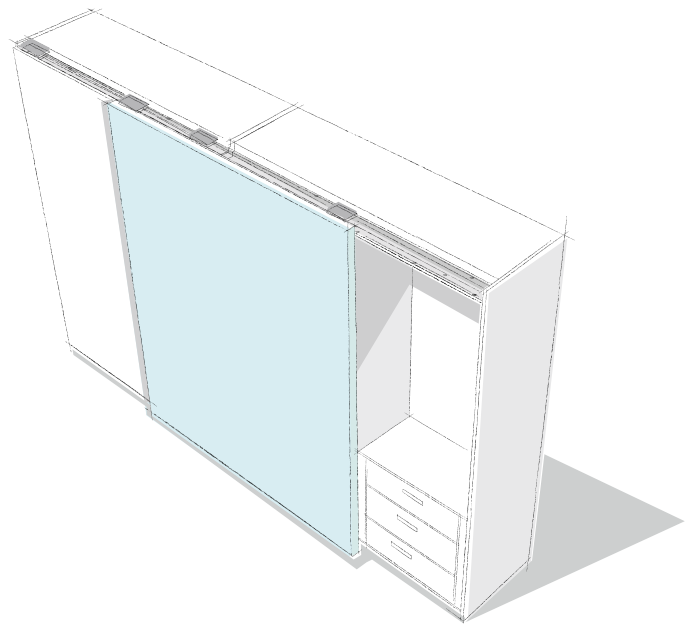

Quality that meets all the demands

The quality of the sliding door systems is monitored continuously. Hettich fittings comply with the national and international quality standards of the markets our customers operate in.

Loading capacity

The values stated in the catalogue for Hettich sliding door systems comprise the permissible total weight of the door in combination with the permitted door sizes. All Hettich sliding door systems pass the overload test to EN 15706. The sliding door systems are suitable for furniture to EN 14749 when processed correctly as specified in the catalogue.

Corrosion test

Hettich sliding door systems satisfy the requirements on corrosion defined in EN 15706, 72-hour condensation-water test to EN 6270.



Functionality

What good cabinet doors need to do

When it comes to cabinet doors, it's the practical aspects most consumers attach importance to, particularly to ease of opening and closing. The benefit of linear movement provided with sliding doors should be combined with low forces needed to open them. Also appreciated is the convenience of Silent System for soft, gentle and silent closing.

The perfect sliding door system is also expected to come with outstanding running performance and give you quality you can rely on.

Technik für Möbel



TopLine XL...

At a glance...

Description	Top running sliding door system for large cabinets with 2, 3 or 4 doors	Door material	Wood
Number of tracks	2	Door width mm	600 - 2000 mm
Door action	Horizontal	Door height mm	3000mm max.
Door position	Overlay	Silent System	Soft closing, soft opening
Door weight	60 kg max.		



Sliding Doors

TopLine XL, 2-Door

The TopLine XL is the key to creating floor to ceiling, large format sliding door units

- Purist design to large surfaces
- Unrivalled user convenience
- Simple yet secure installation
- Low opening force
- Silent System integration
- Convenient height adjustment
- Overlay adjustment



Type/Option/Version	Specification and colour	Product Code	Matching Accessory
---------------------	--------------------------	--------------	--------------------



Running guide set
2-door

HE9275796*



Door straightener
HE0045198



Profile set,
Aluminum
4,000mm

HE9278657*



Silent system set
2-door

HE9276732*

Technical Support

Customers also purchased?



Quadro runner, left
HE9256872



Quadro runner, right
HE9256873



475mm Trousers Pull-out
KS2383837021



475mm Laundry Pull-out
KS2387367021



475mm Tie/belt organiser
KS2383847021

Scope of supply

- 4 x Runner components
- 4 x Guide components
- 1 x Runner profile
- 1 x Guide profile
- 1 x Set profile clips
- 1 x Set soft-opening & closing
- 1 x Set end caps

*all codes to be ordered



Sliding Doors

TopLine XL, 3-Door

The TopLine XL is the key to creating floor to ceiling, large format sliding door units

- Purist design to large surfaces
- Unrivalled user convenience
- Simple yet secure installation
- Low opening force
- Silent System integration
- Convenient height adjustment
- Overlay adjustment



Type/Option/Version	Specification and colour	Product Code	Matching Accessory
	Running guide set 3-door	HE9275786*	 Door straightener HE0045198
	Profile set, Aluminum 4,000mm	HE9278657*	
	Silent system set 3-door	HE9276643*	

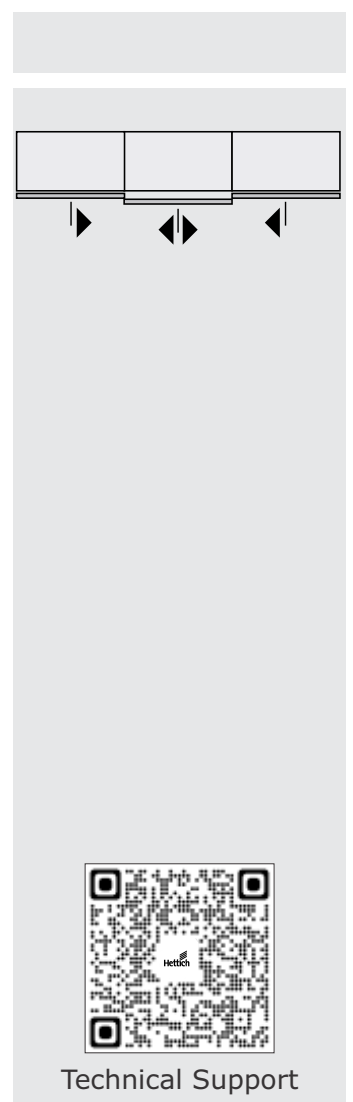

Technical Support

Customers also purchased?



Quadro runner, left
HE9256872



Quadro runner, right
HE9256873



475mm Trouser Pull-out
KS2383837021



475mm Laundry Pull-out
KS2387367021



475mm Tie/belt organiser
KS2383847021

Scope of supply

- 6 x Runner components
- 6 x Guide components
- 1 x Runner profile
- 1 x Guide profile
- 1 x Set profile clips
- 1 x Set soft-opening & closing
- 1 x Middle door dampener
- 1 x Set end caps

*all codes to be ordered



Sliding Doors

TopLine 1200

TopLine 1200 sliding system perfectly aids the creation of walk-in wardrobes & room dividers.

- For 1 sliding door
- Inset design
- For wood or wooden framed doors
- Bottom guide with runner shoe or guiding rod
- 45kg Door weight
- Door thickness from 19mm



Type/Option/Version	Specification and colour	Product Code
---------------------	--------------------------	--------------



TopLine 1200 set
1-door

HE0048293*





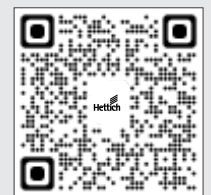
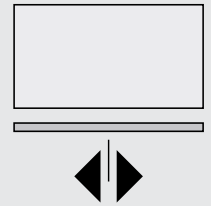

Screw-on profile
Aluminum
3,000mm

HE0048291*



Technical Support

Customers also purchased?

			
550 x 320 YouK rack KS2367509873	905 x 320 YouK rack KS2367549873	1,500 x 320 YouK rack KS2367589873	2,210 x 320 YouK rack KS2367629873

Scope of supply

2 x Running components
2 x Mounting plates
2 x End stops
2 x Bottom guides
1 x Pre-drilled aluminium profile
Fixing material

**all codes to be ordered*



SysLine

At a glance...

Description	Top running sliding door system for cabinets with 1 or 2 doors	Door material	Wood / wood, aluminium
Number of tracks	1 / 2	Door width mm	400 - 1000 mm
Door action	Horizontal	Door height mm	1500 mm max.
Door position	Inset	Silent System	Optional
Door weight	15 kg max.		



Sliding Doors

SysLine S, 2-door

SysLine S moves doors weighing up to 15 kg making optimum use of storage space.

- Concealed system
- Integrated adjustment
- Simple installation
- For door thickness 16mm, 17mm, 18mm and 19mm
- Door weight up to 15kg per panel



Type/Option/Version	Specification and colour	Product Code
---------------------	--------------------------	--------------



Running guide set
2-door

HE9136103*



Screw-on profile
Aluminum
2,000mm

HE9136105*

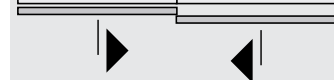
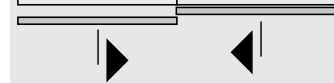
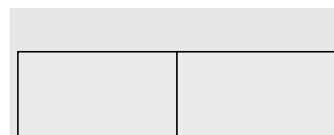

Technical Support

Scope of supply

- 4 x Running components
- 4 x End stops
- 4 x Adapters for wooden doors
- 2 x Bottom guide components for wooden doors
- 2 x Bottom guide components for aluminium framed doors
- 2 x Door stops / spacers
- 1 x Pre-drilled aluminium profile

**all codes to be ordered*



SlideLine M

At a glance...

Description	Bottom running sliding door system	Door material	Wood
Number of tracks	1 or 2	Door width mm	300 - 1800 mm
Door action	Horizontal	Door height mm	2000 mm max.
Door position	Overlay / Inset	Silent System	Soft closing, soft opening, soft colliding
Door weight	30 kg max.		



Sliding Doors

SlideLine M (overlay)

The sliding door system for modern furniture design that offers many applications

- Suitable for overlay doors
- Single-track bottom running system
- Door width 450mm - 1800mm
- Door height 300mm - 2400mm
- Shelf / panel thickness 16mm
- Height adjustment +/- 2mm
- Silent System with activators at any chosen position
- Fast, toolless installation of front panels



Type/Option/Version	Specification and colour	Product Code	Matching Accessory
---------------------	--------------------------	--------------	--------------------



Running guide set
(Soft open & close)

HE9156338*



Door straightener
HE0045198
(Height dependent)



2 x Overlay profile set
16mm, Aluminum
2,500mm each

HE9209165*



Adhesive cover strip
silver
2,500mm only

HE9209232*



Technical Support

Optional Accessories & Spares

Customers also purchased?

--	--	--	--	--

Scope of supply

- 2 x Running sets with Silent System
- 2 x Guide components
- 2 x Activators
- 2 x End stops, top
- 2 x Guide bushes
- 1 x Soft colliding element
- 1 x 1.5 mm hexagon socket spanner
- 2 x Runner profiles
- 2 x Mounting clips
- 1 x Decorative profile
- 2 x End caps (+ 2 replacements)
- Fixing material

*all codes to be ordered



Sliding Doors

SlideLine M (inset)

The sliding door system for modern furniture design that offers many applications

- Suitable for inset doors
- Single-track bottom running system
- Door width 450mm - 1800mm
- Door height 300mm - 2400mm
- Shelf / panel thickness 16mm
- Height adjustment +/- 2mm
- Silent System with activators at any chosen position
- Fast, toolless installation of front panels



Type/Option/Version	Specification and colour	Product Code	Matching Accessory
---------------------	--------------------------	--------------	--------------------



Running guide set
(Soft open & close)

HE9156338*



Door straightener
HE0045198
(Height dependent)



2 x Inset profile set
Aluminum
2,500mm each

HE9227245*

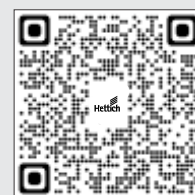
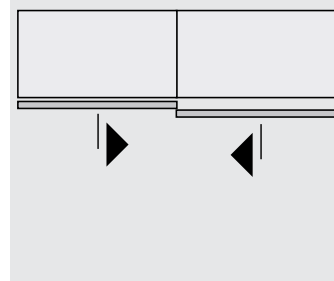
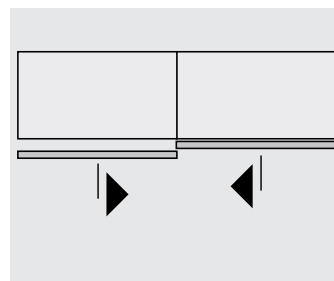
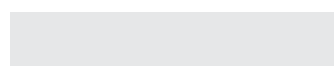

Technical Support

Optional Accessories & Spares

Customers also purchased?

--	--	--	--	--

Scope of supply

- 2 x Running sets with Silent System
- 2 x Guide components
- 2 x Activators
- 2 x End stops, top
- 2 x Guide bushes
- 1 x Soft colliding element
- 1 x 1.5 mm hexagon socket spanner
- 2 x Runner profiles
- 2 x Mounting adapters

*all codes to be ordered



WingLine L

At a glance...

Description	Side mounted folding door system with runner profile at top / guide profile at bottom	Door wing height mm	2400 mm max.
Number of door wings	2		
door wing weight	25 kg max.		
Door material	Wood		
Door wing width mm	600 mm max.		



Folding Doors

WingLine L, 1-Door

The WingLine L offers a completely new dimension of convenience.

- Panorama convenience
- Easy, gentle opening
- Optimum use of space
- Purist & convenient
- Silent System integration
- Impressive performance
- Cost effective



Type/Option/Version	Specification and colour	Product Code	Matching Accessory
---------------------	--------------------------	--------------	--------------------



Left-opening set
1-door

HE9237852*



110° Soft-close hinge set
HE9071208 +
HE9313886



Profile set, top & bottom
Aluminum
2,400mm

HE9239310*

- or -



Right-opening set
1-door

HE9237890*



110° Soft-close hinge set
HE9071208 +
HE9313886



Profile set, top & bottom
Aluminum
2,400mm

HE9239310*

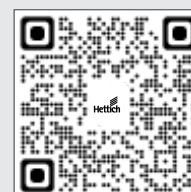
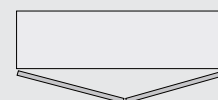
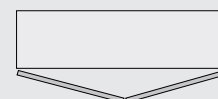

Technical Support

Customers also purchased?



475mm Trousers Pull-out
KS2383837021



475mm Laundry Pull-out
KS2387367021



475mm Tie/belt organiser
KS2383847021

Scope of supply

- 1 x Running component
- 1 x Guide component
- 4 x Folding door hinges
- 2 x Positioning aids, centre hinges
- 1 x Running component cover
- 1 x Stay open element
- 1 x Runner profile
- 1 x guide profile
- 2 x Profile mounting clips
- Fixing material

*all codes per side to be ordered







Folding Doors

WingLine L, 2-Door

The WingLine L offers a completely new dimension of convenience.

- Panorama convenience
- Easy, gentle opening
- Optimum use of space
- Purist & convenient
- Silent System integration
- Impressive performance
- Cost effective



Type/Option/Version	Specification and colour	Product Code	Matching Accessory
	Left-opening set 2-door	HE9237852*	
	Right-opening set 2-door	HE9237890*	
	Profile set, top & bottom Aluminum 2,400mm	HE9239310*	

110° Soft-close hinge set
HE9071208 +
HE9313886

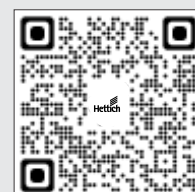
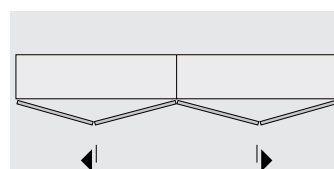

Technical Support

Customers also purchased?



475mm Trouser Pull-out
KS2383837021



475mm Laundry Pull-out
KS2387367021



475mm Tie/belt organiser
KS2383847021

Scope of supply

- 2 x Running component
- 2 x Guide component
- 8 x Folding door hinges
- 4 x Positioning aids, centre hinges
- 2 x Running component cover
- 2 x Stay open element
- 1 x Runner profile
- 1 x Guide profile
- 2 x Profile mounting clips
- Fixing material

*all codes per side to be ordered



Folding Doors

WingLine 230, 2-Door

The giant among folding doors: Opening rooms and large cupboards in a single movement.

- No bottom guide necessary
- Door panel weight max 25kg
- Door panel height max 3000mm
- Door panel width max 600mm





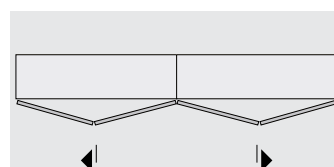

Type/Option/Version	Specification and colour	Product Code	Matching Accessory
	Left & right-opening set 2-door	HE0079015*	 110° Soft-close hinge set HE9071208 + HE9313886
	Profile set, top Aluminum 2,400mm	HE0079013*	



Technical Support

Optional Accessories

Customers also purchased?

			
Door straightener HE0045198	475mm Trousers Pull-out KS2383837021	475mm Laundry Pull-out KS2387367021	475mm Tie/belt organiser KS2383847021

Scope of supply

2 x Running components
10 x Folding door press-in hinges
1 x Runner profile

**all codes to be ordered*



Pocket Doors

Pocket Door, 16mm Follower

A stroke of genius and ideal for Television furniture.

- Smooth action and high side stability through precision slides
- Door weight max 14kg
- Door height max 1800mm
- Door width 300mm - 700mm (slide dependent)
- Door thickness max 22.5mm / 32mm
- With roll-out prevention



Type/Option/Version	Specification and colour	Product Code	Matching Accessory
---------------------	--------------------------	--------------	--------------------



Pocket slide set
KA5740
500mm

HE0041375*



95° Thick door hinge set
HE0073925 +
HE9071628



Accessory set,
KA5740

HE9079526*

- or -



Pocket slide set
KA5740
550mm

HE0041376*



95° Thick door hinge set
HE0073925 +
HE9071628



Accessory set,
KA5740

HE9079526*

Recommended quantity of fittings based on door heights.

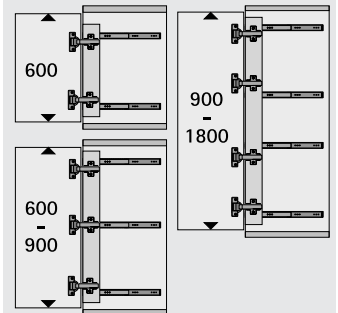

Technical Support

Optional Accessories & Spares

Customers also purchased?

--	--	--	--	--

Scope of supply

- 1 x Pair pocket slides
- 8 x Door spacers, 10 mm ø drilling
- 4 x Support rollers for flaps ø 20 mm
- 4 x Panhead screws ø 4 x 25 mm

*all codes to be ordered per size



Pocket Doors

Pocket Door, 12mm Follower

A stroke of genius and ideal for Television furniture.

- Smooth action and high side stability through precision slides
- Door weight max 14kg
- Door height max 1800mm
- Door width 300mm - 700mm (slide dependent)
- Door thickness max 22.5mm / 32mm
- With roll-out prevention



Type/Option/Version	Specification and colour	Product Code	Matching Accessory
---------------------	--------------------------	--------------	--------------------



Pocket slide set
KA5740
500mm

HE0041375*



95° Thick door hinge set
HE9090260 +
HE9071670



Accessory set,
KA5740

HE9079526*

- or -



Pocket slide set
KA5740
550mm

HE0041376*



95° Thick door hinge set
HE9090260 +
HE9071670



Accessory set,
KA5740

HE9079526*

Recommended quantity of fittings based on door heights.

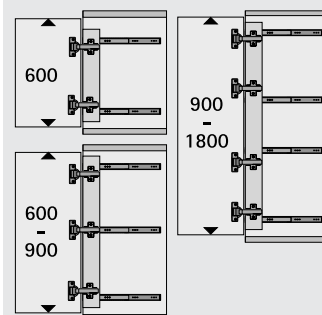

Technical Support

Scope of supply

- 1 x Pair pocket slides
- 8 x Door spacers, 10 mm ø drilling
- 4 x Support rollers for flaps ø 20 mm
- 4 x Panhead screws ø 4 x 25 mm

*all codes to be ordered per door size

Panorama effects for more room in the room



WingLine

Whilst Larson has used its best endeavours to ensure that the information provided in this catalogue - including (but not limited to) technical specifications, measurements and colours - are accurate and up to date at the time of issue, does not warrant that it is correct or complete. We reserve the right to make corrections and changes without notification and unless otherwise stated and agreed upon in writing, Larson makes no warranties of any kind, express or implied, that goods sold are suitable for any particular purpose or application under any specific condition. It is recommended that every item should be thoroughly tested by the purchaser to determine performance suitability before use of goods.



www.larson.co.za