

A woman with dark hair tied back is shown in profile, looking at a silver Hettich concealed hinge on a light-colored cabinet door. The hinge is partially open, revealing its internal mechanism. To the right, a clear glass sits on a white shelf. Below the cabinet, two stainless steel pots filled with fresh green basil are visible on a dark countertop. The overall scene is brightly lit, suggesting a clean, modern kitchen environment.

Hettich

Fast-assembly concealed hinges for all cabinetry applications.

Edition 1

A close-up shot of hands in a light blue shirt chopping fresh vegetables on a wooden cutting board. The vegetables include red tomatoes and green cucumbers. The background is slightly blurred, focusing attention on the hands and the fresh produce.

Introducing Veosys: The stainless steel hinge for the African outdoors



Its stainless steel finish makes the Veosys hinge from Hettich a robust all rounder. Resilient to temperature fluctuations and moisture, Veosys comes with tested resistance to corrosion. Produced from stainless steel equivalent to kitchen sinks, it's ideal for challenging design situations. The integrated Silent System operates smoothly over an impressive temperature range, and with its uniquely wide self closing angle of 35°, Veosys closes doors almost by itself. Choose Veosys for coastal homes, built-in outdoor kitchens, indoor pools & gyms - or any other high salt or moisture environment.



Sensys: Beautiful. And beautifully quiet.

Sensys has an elegant, contemporary look and meets customer expectations for outstanding design and quality. The simple, sleek, harmonious lines of the design - from the cup and the arm cover cap to the mounting plate - give the hinge its streamlined modern look. All edges and radii contribute to the perfect harmony of hinge and mounting plate. Silent system dampening is integrated invisibly in the hinge as is the unlatch tab. Specially designed cover caps conceal fixing screws and adaptors.



Intermat: Sound quality for reliability.

Intermat is the handy and versatile hinge for fast assembly. It is particularly easy to fit and can be adjusted without effort. Intermat hinges can be used for virtually every application. Intermat offers tangible convenience in everyday use.



Novisys: Silent system ease for everyone

Furniture buyers on a limited budget are also expecting more and more practical convenience. Novisys now makes integrated Silent System convenience the standard for all users. This is where our "made by Hettich" quality product demonstrates reliable soft closing performance.

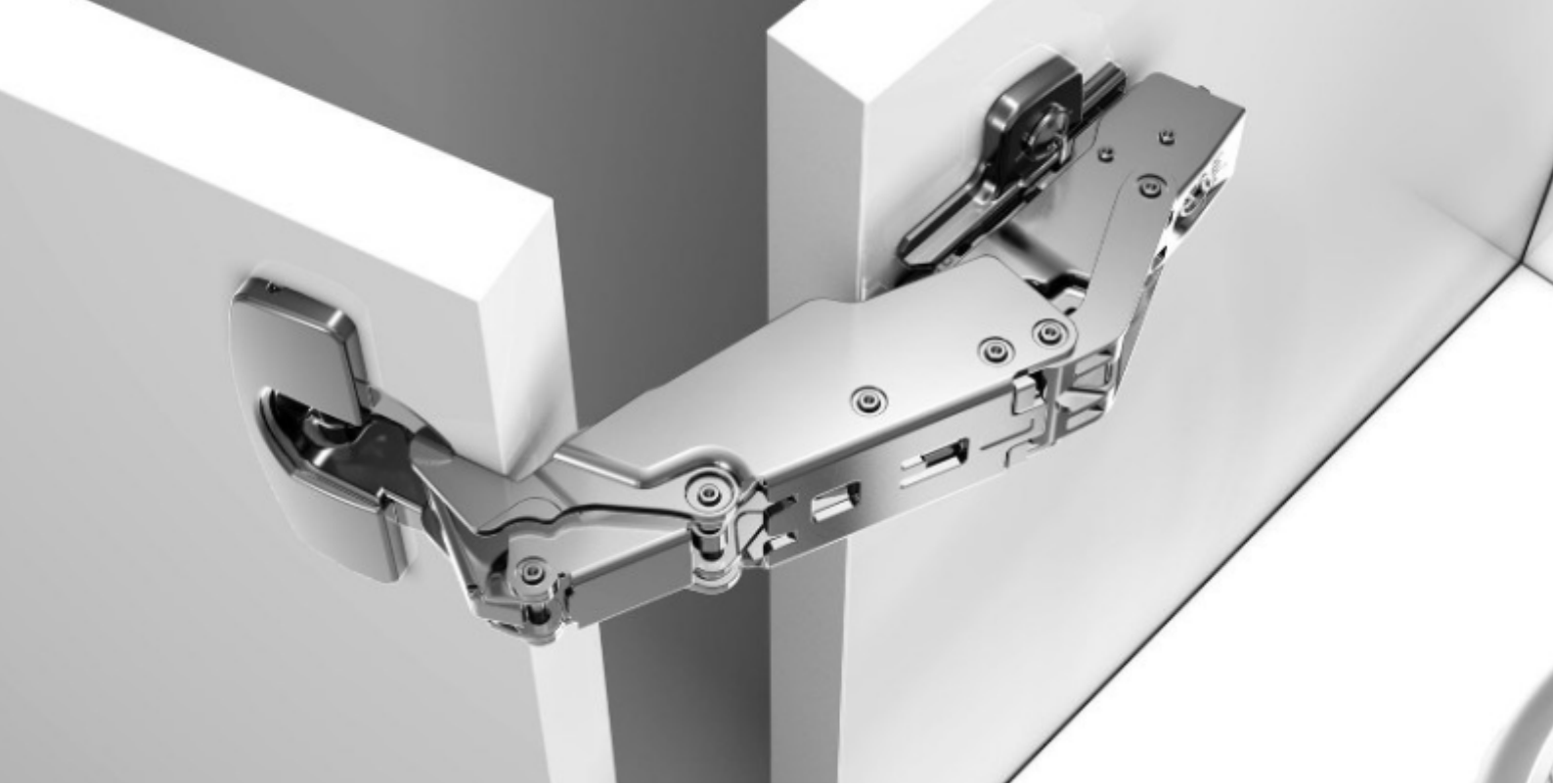

Hinges from Hettich are the heart of good doors: innovative, reliable and long lasting. They provide top quality as well as clever mounting and adjustment capabilities. The Sensys and Interimat fast assembly hinges are particularly easy to fit and can be adjusted without any effort. The multiple award winning Sensys hinge has revolutionised the world of hinges with its invisibly integrated Silent System. Together with Interimat, both hinges provide solutions for practically every application. Hinging on perfection, with Hettich.

Door width, height and weight as well as the material quality of the door are decisive factors determining the number of hinges required. The factors encountered in each individual case differ enormously. For this reason the number of hinges shown in the diagram below should only be taken as a guide. If in doubt it is advisable to produce a trial mounting or increase the number of hinges. For reasons of stability, the distance between hinges must always be made as large as possible.

Hettich hinges make light work of inaccuracies with their high level of adjustment.

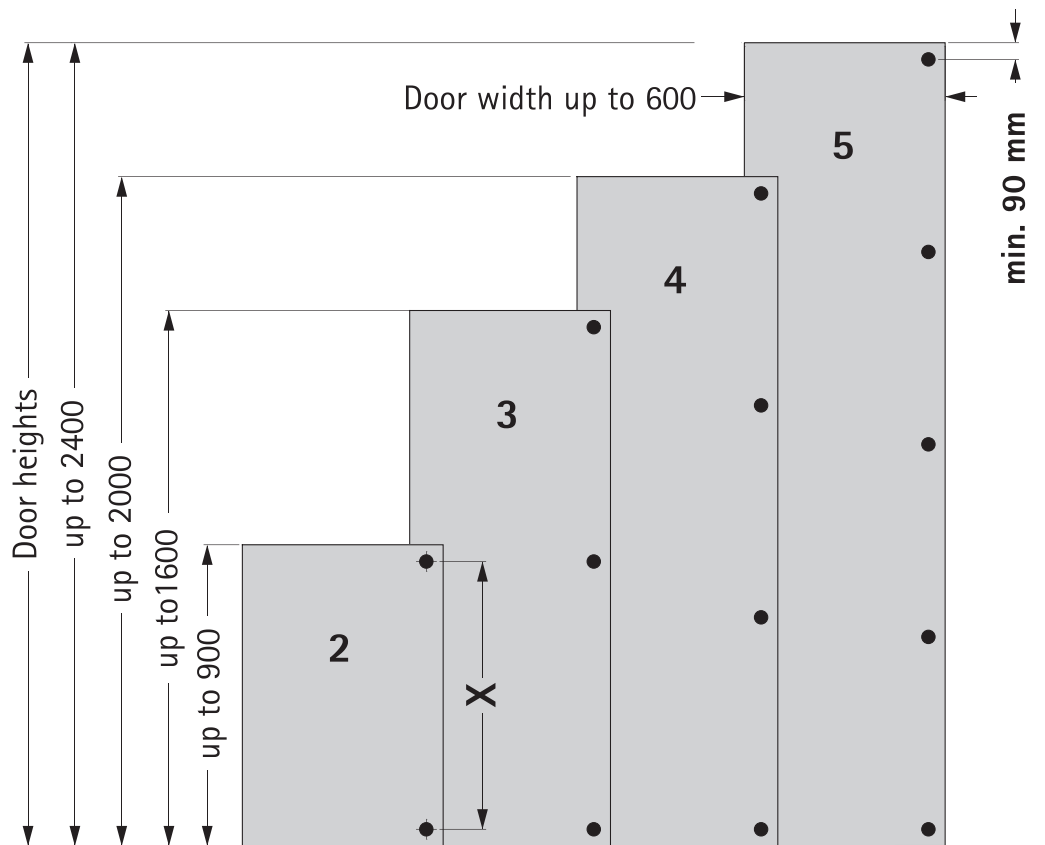
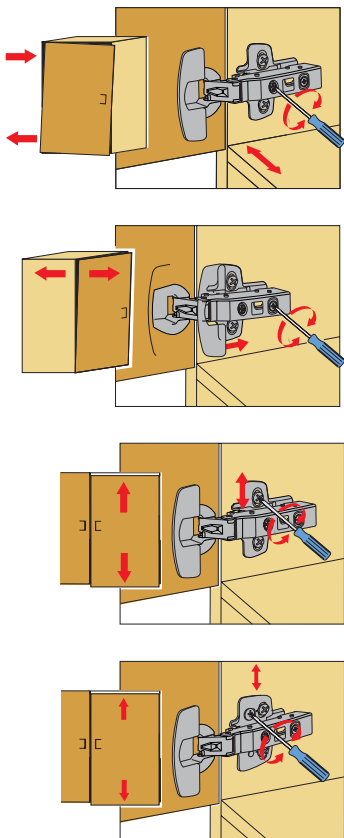

*Door guide for Sensys 110° hinges

(Guide values for 19 mm chipboard panels with a density of 750 kg/m³)

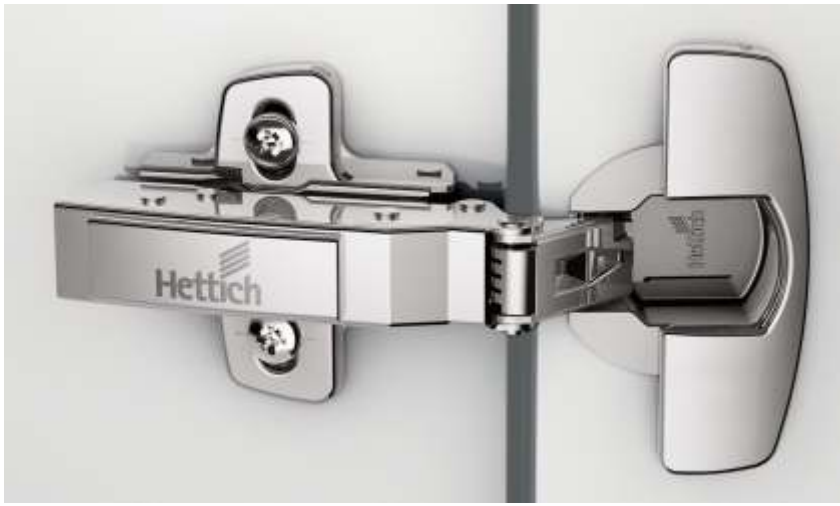

Hinges

Sensys TH52

Sensys 110° hinge with integrated Silent System, TH-drilling pattern 52

- Silent system feature
- 110° opening angle
- For door thickness 15 - 24 mm
- Available in full overlay, half overlay and inset
- Cup depth 12.8 mm
- Fast assembly
- Integrated overlay adjustment +2mm/-2mm
- Integrated depth adjustment +3mm/-2mm

Type/Option/Version	Specification and colour	Product Code	Matching Accessory
	Sensys 110° full overlay Steel nickle plated Press-in	HE9071208	
	Sensys 110° half overlay Steel nickle plated Press-in	HE9071209	
	Sensys 110° inset Steel nickle plated Press-in	HE9071210	

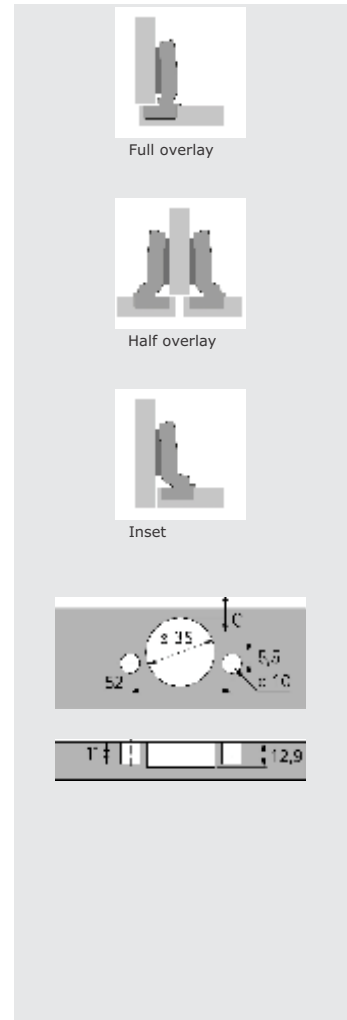

Scope of supply

1 x Hinge

Mounting plate sold separately

Optional Accessories & Spares

				
Hinge arm cover HE9088250	Hinge cup cover HE9088251	1.8mm Potting spacer HE9073595	Hinge drilling jig HE0020165	BlueMax Mini 1Phase HE0047222

Customers also purchased









Hinges

Sensys TB45

Sensys 110° hinge with integrated Silent System, TB-drilling pattern 45

- Silent system feature
- 110° opening angle
- For door thickness 15 - 24 mm
- Available in full overlay, half overlay and inset
- Cup depth 12.8 mm
- Available in Screw-on or press-in assembly
- Integrated overlay adjustment +2mm/-2mm
- Integrated depth adjustment +3mm/-2mm



Type/Option/Version	Specification and colour	Product Code	Matching Accessory
	Sensys 110° full overlay Steel nickle plated Screw-on	HE9071223	 Mounting plate HE9313886
	Sensys 110° half overlay Steel nickle plated Screw-on	HE9071224	 Mounting plate HE9313886
	Sensys 110° inset Steel nickle plated Screw-on	HE9071225	 Mounting plate HE9313886
	Sensys 110° full overlay Steel nickle plated Press-in	HE9071226	 Mounting plate HE9313886
	Sensys 110° half overlay Steel nickle plated Press-in	HE9071227	 Mounting plate HE9313886
	Sensys 110° inset Steel nickle plated Press-in	HE9071228	 Mounting plate HE9313886

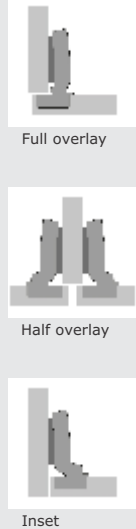

Full overlay

Half overlay

Inset

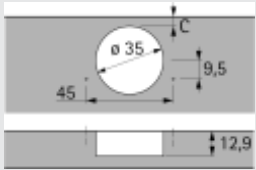

Scope of supply

1 x Hinge

Mounting plate sold separately

Optional Accessories & Spares

				
Hinge arm cover HE9088250	Hinge dowel HEDOWEL	Hinge screw HESCREW		

Hinges

Novisys TH52

Novisys 105° hinge with integrated Silent System, TH-drilling pattern 52

- Silent system feature
- 105° opening angle
- For door thickness 14 - 24 mm
- Available in full overlay, half overlay and inset
- Cup depth 11.8 mm
- Fast assembly
- Integrated overlay adjustment +2mm/-2mm
- Integrated depth adjustment +2.8mm/-1.2mm



Type/Option/Version	Specification and colour	Product Code	Matching Accessory
---------------------	--------------------------	--------------	--------------------



Novisys 105° full overlay
Steel nickle plated
Press-in

HE9313101



Mounting plate
HE9313886



Novisys 105° half overlay
Steel nickle plated
Press-in

HE9313111



Mounting plate
HE9313886



Novisys 105° inset
Steel nickle plated
Press-in

HE9313121



Mounting plate
HE9313886



Full overlay



Half overlay



Inset

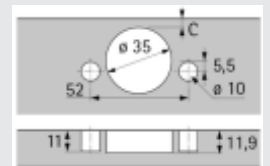

Customers also purchased



Hinge drilling jig
HE0020165



BlueMax Mini 1Phase
HE0047222

Scope of supply

1 x Hinge

Mounting plate sold separately











Hinges

Novisys TB45

Novisys 105° hinge with integrated Silent System, TB-drilling pattern 45

- Silent system feature
- 105° opening angle
- For door thickness 14 - 24 mm
- Available in full overlay, half overlay and inset
- Cup depth 11.8 mm
- Fast assembly
- Integrated overlay adjustment +2mm/-2mm
- Integrated depth adjustment +2.8mm/-1.2mm



Type/Option/Version	Specification and colour	Product Code	Matching Accessory
	Novisys 105° full overlay Steel nickle plated Screw-on	HE9313190	 Mounting plate HE9313886
	Novisys 105° half overlay Steel nickle plated Screw-on	HE9313200	 Mounting plate HE9313886
	Novisys 105° inset Steel nickle plated Screw-on	HE9313210	 Mounting plate HE9313886
	Novisys 105° full overlay Steel nickle plated Press-in	HE9313191	 Mounting plate HE9313886
	Novisys 105° half overlay Steel nickle plated Press-in	HE9313201	 Mounting plate HE9313886
	Novisys 105° inset Steel nickle plated Press-in	HE9313211	 Mounting plate HE9313886

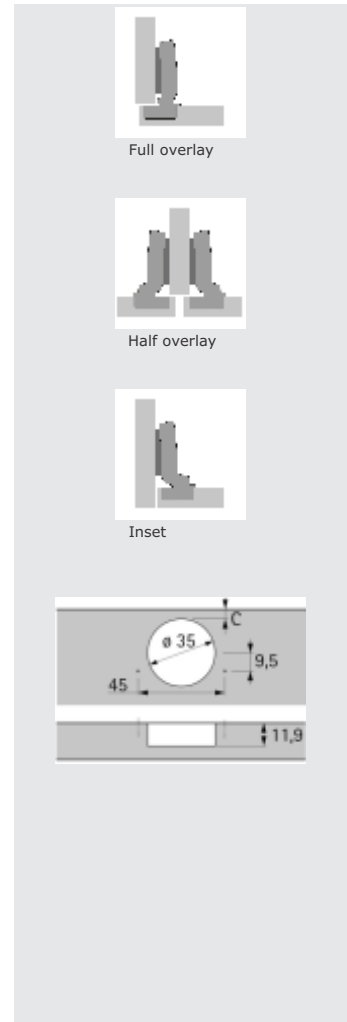

Scope of supply

1 x Hinge

Mounting plate sold separately

Optional Accessories & Spares

			
Hinge dowel HEDOWEL	Hinge screw HESCREW		



Hinges

Sensys TH52

Sensys 165° hinge with integrated Silent System, TH-drilling pattern 52 for wide angles with zero protrusion

- Silent system feature
- 165° opening angle
- Zero protrusion
- For door thickness 15 - 32 mm
- Available in full overlay
- Cup depth 11.6 mm
- Fast assembly
- Integrated overlay adjustment +2mm/-2mm
- Integrated depth adjustment +3mm/-2mm

Type/Option/Version	Specification and colour	Product Code	Matching Accessory
---------------------	--------------------------	--------------	--------------------



Sensys 165° full overlay
Steel nickle plated
Zero protrusion
Press-in

HE9099541



Mounting plate
HE9313886



Full overlay

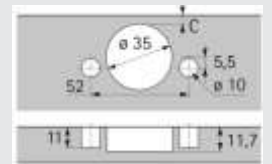

Optional Accessories & Spares



Hinge cup cover
HE9088251



1.8mm Potting spacer
HE9073595

Customers also purchased



Hinge drilling jig
HE0020165



BlueMax Mini 1Phase
HE0047222

Scope of supply

1 x Hinge

Mounting plate sold separately





Hinges

Sensys TB45

Sensys 165° hinge with integrated Silent System, TB-drilling pattern 45 for wide angles with zero protrusion

- Silent system feature
- 165° opening angle
- Zero protrusion
- For door thickness 15 - 32 mm
- Available in full overlay
- Cup depth 11.6 mm
- Fast assembly
- Integrated overlay adjustment +2mm/-2mm
- Integrated depth adjustment +3mm/-2mm



Type/Option/Version	Specification and colour	Product Code	Matching Accessory
	Sensys 165° full overlay Steel nickle plated Zero protrusion Screw-on	HE9099560	 Mounting plate HE9313886
	Sensys 165° full overlay Steel nickle plated Zero protrusion Press-in	HE9099561	 Mounting plate HE9313886



Full overlay

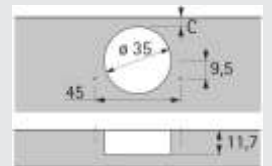

Scope of supply

1 x Hinge

Mounting plate sold separately

Optional Accessories & Spares

				
Hinge dowel HEDOWEL	Hinge screw HESCREW			



Hinges

Sensys Thick Door Hinges

Sensys 95° hinge with self-closing feature, TH-drilling pattern 52

- Self-closing feature
- 95° opening angle
- For doors 15-32mm thick
- Available in full overlay, half overlay and inset
- Cup depth 12.8 mm
- Fast assembly
- Integrated overlay adjustment +2mm/-2mm
- Integrated depth adjustment +3mm/-2mm



Type/Option/Version	Specification and colour	Product Code	Matching Accessory
	Sensys 95° full overlay 15-32mm door thickness Steel nickle plated Screw-on	HE9090260	 Mounting plate HE9313886
	Sensys 95° half overlay 15-32mm door thickness Steel nickle plated Screw-on	HE9091410	 Mounting plate HE9313886
	Sensys 95° inset 15-32mm door thickness Steel nickle plated Screw-on	HE9091420	 Mounting plate HE9313886



Full overlay



Half overlay



Inset

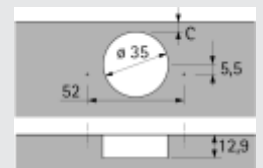

Scope of supply

1 x Hinge

Mounting plate sold separately

Optional Accessories & Spares

				
Hinge arm cover HE9088250	Hinge cup cover HE9088251			

Hinges

Sensys Thin Door Hinges

Sensys 110° hinge with self-closing feature for thin doors, TH-drilling pattern 52

- Self-closing feature
- 110° opening angle
- For doors 10-19mm thick
- Available in full overlay
- Cup depth 7.8 mm
- Fast assembly
- Integrated overlay adjustment +2mm/-2mm
- Integrated depth adjustment +3mm/-2mm



Type/Option/Version	Specification and colour	Product Code	Matching Accessory
---------------------	--------------------------	--------------	--------------------



Sensys 110° full overlay
10-19mm door thickness
Steel nickle plated
Screw-on

HE9094270



Mounting plate
HE9313886



Full overlay

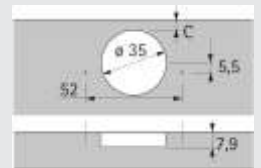

Scope of supply

1 x Hinge

Mounting plate sold separately

Optional Accessories & Spares



Hinge arm cover
HE9088250



Hinge cup cover
HE9088251

Hinges

Sensys Angle TH52 (inset)

Sensys 95° hinge with integrated Silent System, TH-drilling pattern 52

- Silent system feature
- 95° opening angle
- For door thickness 15 - 28 mm
- Available in inset (W90)
- Cup depth 12.8 mm
- Fast assembly
- Integrated adjustment of door offset +1mm/-2mm
- Integrated reveal adjustment +3mm/-2mm



Type/Option/Version	Specification and colour	Product Code	Matching Accessory
---------------------	--------------------------	--------------	--------------------



Sensys 95° inset
Steel nickle plated
W90 inset
Press-in

HE9088039



Mounting plate
HE9313886



Inset

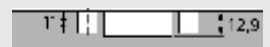
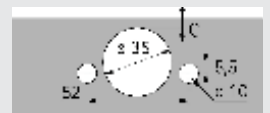

Scope of supply

1 x Hinge

Mounting plate sold separately

Optional Accessories & Spares

Customers also purchased



Hinge arm cover
HE9088250



Hinge cup cover
HE9088251



1.8mm Potting spacer
HE9073595



Hinge drilling jig
HE0020165



BlueMax Mini 1Phase
HE0047222

Hinges

Sensys Angle TB45 (inset)

Sensys 95° hinge with integrated Silent System, TB-drilling pattern 45

- Silent system feature
- 95° opening angle
- For door thickness 15 - 28 mm
- Available in inset (W90)
- Cup depth 12.8 mm
- Fast assembly
- Integrated adjustment of door offset +1mm/-2mm
- Integrated reveal adjustment +3mm/-2mm



Type/Option/Version	Specification and colour	Product Code	Matching Accessory
---------------------	--------------------------	--------------	--------------------



Sensys 95° inset
Steel nickel plated
W90 inset
Screw-on

HE9088027



Mounting plate
HE9313886



Sensys 95° inset
Steel nickel plated
W90
Press-in

HE9088045



Mounting plate
HE9313886



Inset

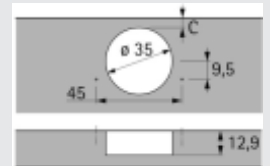

HE9088027

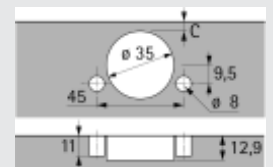

HE9088045

Scope of supply

1 x Hinge

Mounting plate sold separately

Optional Accessories & Spares



Hinge arm cover
HE9088250



Hinges

Sensys Angle TH52 (overlay)

Sensys 95° hinge with integrated Silent System, TH-drilling pattern 52

- Silent system feature
- 95° opening angle
- For door thickness 15 - 28 mm
- Available in full overlay (W45)
- Cup depth 12.8 mm
- Fast assembly
- Integrated overlay adjustment +2mm/-2mm
- Integrated depth adjustment +3mm/-2mm

Type/Option/Version	Specification and colour	Product Code	Matching Accessory
---------------------	--------------------------	--------------	--------------------

	Sensys 95° full overlay Steel nickle plated W45 overlay Press-in	HE9088037	Mounting plate HE9313886
--	---	-----------	-----------------------------

Scope of supply
1 x Hinge
Mounting plate sold separately

Optional Accessories & Spares

Customers also purchased

Hinge arm cover HE9088250	Hinge cup cover HE9088251	1.8mm Potting spacer HE9073595	Hinge drilling jig HE0020165	BlueMax Mini 1Phase HE0047222
------------------------------	------------------------------	-----------------------------------	---------------------------------	----------------------------------



Hinges

Sensys Angle TB45 (overlay)

Sensys 95° hinge with integrated Silent System, TB-drilling pattern 45

- Silent system feature
- 95° opening angle
- For door thickness 15 - 28 mm
- Available in full overlay (W45)
- Cup depth 12.8 mm
- Fast assembly
- Integrated overlay adjustment +2mm/-2mm
- Integrated depth adjustment +3mm/-2mm

Type/Option/Version	Specification and colour	Product Code	Matching Accessory
	Sensys 95° full overlay Steel nickle plated W45 overlay Screw-on	HE9088024	 Mounting plate HE9313886
	Sensys 95° full overlay Steel nickle plated W45 Press-in	HE9088042	 Mounting plate HE9313886



Full overlay

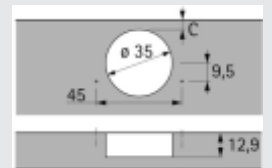

Scope of supply

1 x Hinge

Mounting plate sold separately

Optional Accessories & Spares



Hinge arm cover
HE9088250



Hinges

Intermat TH52

Intermat 110° hinge with self-closing feature, TH-drilling pattern 52

- Self-closing feature
- 110° opening angle
- For door thickness 15 - 25 mm
- Available in full overlay, half overlay and inset
- Cup depth 11.6 mm
- Fast assembly
- Integrated overlay adjustment +2mm/-2mm
- Integrated depth adjustment +2.5mm/-1.5mm

Type/Option/Version	Specification and colour	Product Code	Matching Accessory
---------------------	--------------------------	--------------	--------------------



Intermat 110° full overlay
Steel nickle plated
Press-in

HE1029520



Mounting plate
HE9313886



Intermat 110° half overlay
Steel nickle plated
Press-in

HE1030622



Mounting plate
HE9313886



Intermat 110° inset
Steel nickle plated
Press-in

HE1030924



Mounting plate
HE9313886



Full overlay



Half overlay



Inset

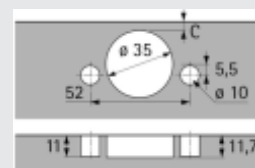

Scope of supply

1 x Hinge

Mounting plate sold separately

Customers also purchased



Hinge drilling jig
HE0020165



BlueMax Mini 1Phase
HE0047222

Hinges

Intermat TB45

Intermat 110° hinge with self-closing feature, TB-drilling pattern 45

- Self-closing feature
- 110° opening angle
- For door thickness 15 - 25 mm
- Available in full overlay, half overlay and inset
- Cup depth 11.6 mm
- Fast assembly
- Integrated overlay adjustment +2mm/-2 mm
- Integrated depth adjustment +2.5mm/-1.5 mm



Type/Option/Version	Specification and colour	Product Code	Matching Accessory
	Intermat 110° full overlay Steel nickle plated Screw-on	HE1073711	
	Intermat 110° half overlay Steel nickle plated Screw-on	HE9046806	
	Intermat 110° inset Steel nickle plated Screw-on	HE9046807	
	Intermat 110° full overlay Steel nickle plated Press-in	HE1029522	
	Intermat 110° half overlay Steel nickle plated Press-in	HE1030921	
	Intermat 110° inset Steel nickle plated Press-in	HE1030925	



Full overlay

Half overlay

Inset

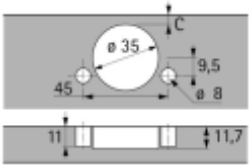

Scope of supply

1 x Hinge

Mounting plate sold separately



Hinges

Intermat Thick Door Hinge

Intermat 95° hinge with self-closing feature, TH-drilling pattern 52 for thick doors

- Self-closing feature
- 95° opening angle
- For door thickness 26 - 43mm
- Available in full overlay
- Cup depth 13.7 mm
- Fast assembly
- Integrated overlay adjustment +2mm/-2mm
- Integrated depth adjustment +2.5mm/-1.5mm

Type/Option/Version	Specification and colour	Product Code	Matching Accessory
---------------------	--------------------------	--------------	--------------------



Intermat 95° full overlay
Steel nickle plated
Screw-on

HE0073925



Mounting plate
HE9313886



Full overlay

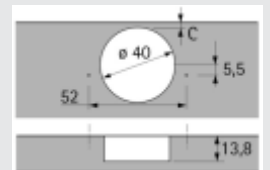

Customers also purchased



Hinge drilling jig
HE0020165



BlueMax Mini 1Phase
HE0047222

Scope of supply

1 x Hinge

Mounting plate sold separately



Hinges

Interimat TH52

Interimat 165° hinge with self-closing feature, TH-drilling pattern 52 for wide angles with zero protrusion

- Self-closing feature
- 165° opening angle
- Zero protrusion
- For door thickness 15-32mm
- Available in full overlay
- Cup depth 11.6 mm
- Fast assembly
- Integrated overlay adjustment +2mm/-2mm
- Integrated depth adjustment +3mm/-2mm

Type/Option/Version	Specification and colour	Product Code	Matching Accessory
---------------------	--------------------------	--------------	--------------------



Interimat 165° full overlay
Steel nickle plated
Zero protrusion
Press-in

HE9099601



Mounting plate
HE9313886



Full overlay

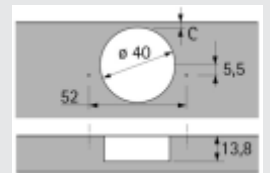

Scope of supply

1 x Hinge

Mounting plate sold separately

Customers also purchased



Hinge drilling jig
HE0020165



BlueMax Mini 1Phase
HE0047222



Hinges

Interimat TB45

Interimat 165° hinge with self-closing feature, TB-drilling pattern 45 for wide angles with zero protrusion

- Self-closing feature
- 165° opening angle
- Zero protrusion
- For door thickness 15-24mm
- Available in full overlay
- Cup depth 11.6 mm
- Fast assembly
- Integrated overlay adjustment +2mm/-2mm
- Integrated depth adjustment +3mm/-2mm

Type/Option/Version	Specification and colour	Product Code	Matching Accessory
	Interimat 165° full overlay Steel nickle plated Zero protrusion Screw-on	HE9099770	 Mounting plate HE9313886
	Interimat 110° full overlay Steel nickle plated Zero protrusion Press-in	HE9099771	 Mounting plate HE9313886



Full overlay

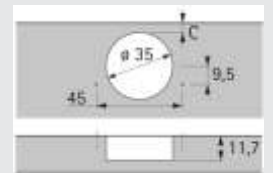

Scope of supply

1 x Hinge

Mounting plate sold separately



Hinges

Interimat Corner Cabinet Hinge

Interimat 50°/65° corner cabinet hinge for folding doors with TH-drilling pattern 52.

- 50°/65° opening angle
- For door thickness 15-21mm
- Available in full overlay
- Cup depth 10.5 mm
- Fast assembly
- Integrated diagonal adjustment +9.5mm/-9.5mm
- Integrated overlay adjustment
- Integrated depth adjustment

Type/Option/Version	Specification and colour	Product Code	Matching Accessory
---------------------	--------------------------	--------------	--------------------



Interimat 50°/65°
Full overlay
Steel/die-cast zinc
nickle plated
Press-in

HE0045037



Mounting plate
HE9313886

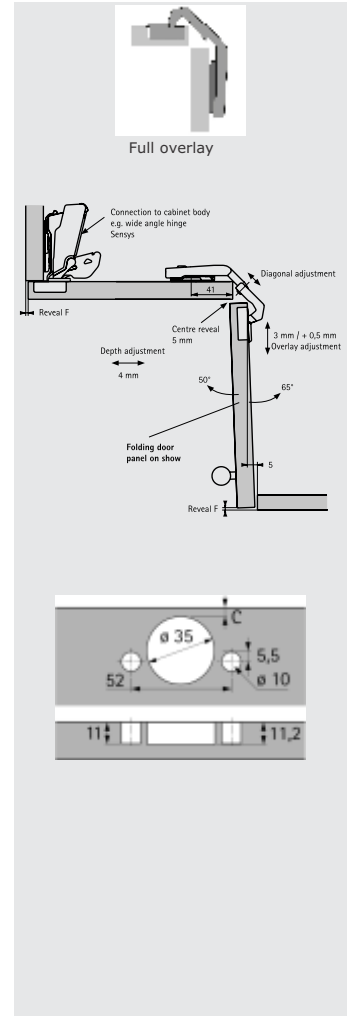

Customers also purchased



Interimat wide angle
HE9099601

Scope of supply

1 x Hinge

Mounting plate sold separately

Hinges

Veosys TH52

Veosys 105° corrosion resistant hinge with integrated Silent System, TH-drilling pattern 52

- Silent system feature
- 105° opening angle
- Corrosion resistant stainless steel*
- For door thickness 14 - 22 mm
- Available in full overlay
- Cup depth 11.5 mm
- Fast assembly
- Integrated overlay adjustment +2mm/-2mm
- Integrated depth adjustment +2.5mm/-1.5mm



Type/Option/Version	Specification and colour	Product Code	Matching Accessory
---------------------	--------------------------	--------------	--------------------



Veosys 105° full overlay
Stainless steel
Screw-on

HE9289590



Mounting plate
HE9289609



Full overlay

*Corrosion resistance is effective in an environment that is harsher than standard. Applications that are in extremely harsh conditions may still suffer from extended exposure to elements.

Scope of supply

1 x Hinge

Mounting plate sold separately

Hinges

Kamat Guiding Hinge

The special 115° hinge for integrated appliance cabinets with extra high fronts.

- 115° opening angle
- Precision reveal alignment
- For door thickness 16-19mm
- Used only in conjunction with Hettich K hinges
- Installed depth 41.5mm



Type/Option/Version	Specification and colour	Product Code	Matching Accessory
	Kamat 115° hinge Steel nickle plated Zero protrusion Screw-on	HE9239784	
	White cover cap Plastic <i>Included</i>		

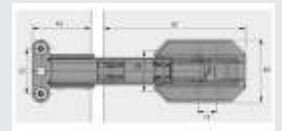





Scope of supply

- 1 x Hinge
- 1 x Drilling template
- 1 x Spacer for 16mm cabinet body
- 1 x Set distance plates
- 1 x Cover cap
- 1 x Set fixing screws
- 1 x Installation guide

Hettich mounting plates

Hettich mounting plates offer secure and reliable hinge fastening with the added benefit of variable adjustment.



Type/Option/Version	Specification and colour	Product Code	Matching Accessory
	3mm mounting plate with direct height adjustment Nickel-plated	HE9071672	
	3mm mounting plate with oblong hole height adjustment Nickel-plated	HE9313885	
	5mm mounting plate with oblong hole height adjustment Nickel-plated	HE9071628	
	1.5mm mounting plate with oblong hole height adjustment Nickel-plated	HE9071576	
	4.5mm face fram mounting plate with oblong hole height adjustment Nickel-plated	HE0079383	

Scope of supply

1 x Mounting plate

Push-to-open plunger

Push-to-open long-travel piston for a screw-on application

- For use with concealed hinges
- Suitable for full overlay, half overlay and inset doors
- Large adjustment range of 6 mm
- Opening movement 1.4mm
- Plastic



Type/Option/Version	Specification and colour	Product Code	Matching Accessory
---------------------	--------------------------	--------------	--------------------



Push-to-open pin
Plastic, anthracite
Screw-on

HE9089626

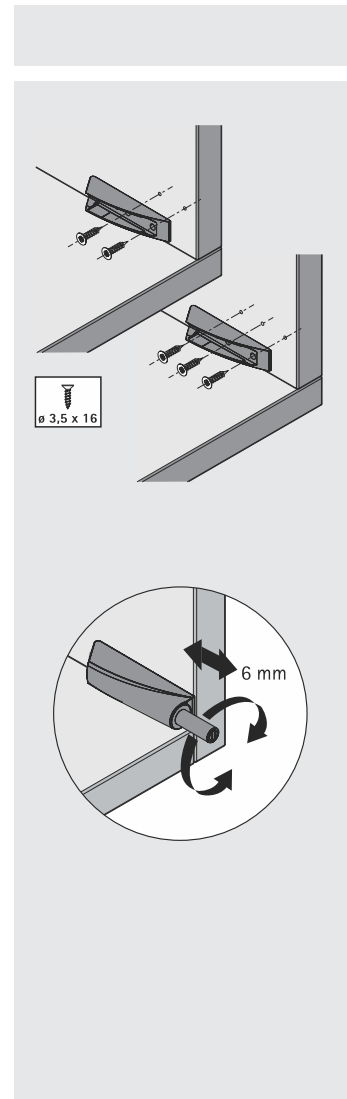

Scope of supply

- 1 x Push-to-open in
- 1 x Adapter top section
- 1 x Adapter base section

Optional Accessories & Spares

Customers also purchased



110° Full overlay hinge
HE1029520



Mounting plate
HE9313886

Compact power drill with hand lever



- Drilling unit with 6 drilling spindles
- Fence with work bench
- 1 set of drill bits (1 x 35 mm \varnothing clockwise, 2 x 10 mm \varnothing anticlockwise)
- 2 pendulum stops
- Please order drill bits separately

BlueMax Mini

Whilst Larson has used its best endeavours to ensure that the information provided in this catalogue - including (but not limited to) technical specifications, measurements and colours - are accurate and up to date at the time of issue, does not warrant that it is correct or complete. We reserve the right to make corrections and changes without notification and unless otherwise stated and agreed upon in writing, Larson makes no warranties of any kind, express or implied, that goods sold are suitable for any particular purpose or application under any specific condition. It is recommended that every item should be thoroughly tested by the purchaser to determine performance suitability before use of goods.
