

in sink erator[®]



Kitchen Better.[™]

Edition 1

Food Waste Disposers



Making kitchens clean, hygienic and environmentally responsible for over 70 years.

Food waste disposers make life easier and better. InSinkErator food waste disposers are the best-selling brand in the world, and with good reason: they're the easiest disposers to install and they provide the greatest peace of mind.



Evolution 200

Evolution 100

Model 66

Model 56

Food Waste Disposers Explained

Many people are under the impression that food waste disposers utilise spinning blades to chop and break down food waste. In fact, nothing could be further than the truth.

InSinkErator food waste disposer units use no blades whatsoever. Instead, impellers mounted on a spinning plate use centrifugal power to force food waste particles against a grind ring. That ring breaks down the food waste into very fine particles – virtually liquefying them.

Running water from the tap then flushes the particles through the grind ring out of the disposer and into your wastewater pipe. From there it flows to the wastewater treatment plant or your septic system.



Advanced Technology

- 1. QuickLock Sink Mount**
Available only from InSinkErator, this "twist-on, twist-off" sink mount makes installation fast and easy, no matter what disposer you're replacing.
- 2. SoundSeal Technology**
In order to reduce noise we've created SoundSeal technology, featuring an exclusive Anti-Vibration Mount, Quiet Collar and SoundLimiter insulation technology. The result is a noise reduction of up to 60%.

- 3. MultiGrind Technology**
At the heart of the Evolution PRO Series is exclusive new MultiGrind technology. With new features such as GrindShear Ring, Tri-Action Lug System® and Undercutter Disk, the 3-stage design makes quick work of both hard and fibrous foods. You can stop worrying about what food waste you can or cannot put in your disposer.

- 4. DuraDrive Induction Motor**
These powerful, heavy-duty motors are manufactured by InSinkErator to exacting specifications that help ensure high performance and long life.

- 5. PowerBoost Micro Processor**
Detects when the motor is under extra load and delivers more power to boost the grinding capability.

How to select the right food waste disposer for your needs





Feed a disposer, starve a landfill!

In South Africa, 10 million tonnes of food go to waste every year. This accounts for a third of the 31 million tonnes that are produced annually in South Africa. Of these 10 million tonnes, most of the waste ends up in landfills. InSinkEerator food waste disposers divert food waste from landfills where it would inevitably settle and produce methane, a harmful greenhouse gas.

Tips to managing food waste

Tip #1 - Shop responsibly

Make a shopping list of items you need before you get to the supermarket. Only buy enough fresh foods for a week. Choose shelf-stable foods like canned goods, pasta, rice and legumes. Utilise your freezer to store bread, meats, vegetables and fruit.

Tip #2 - Plan meals & save leftovers

Taking an inventory of your pantry is a great first step to plan your meals and avoid food waste. Check expiration dates to use foods before they go bad. Plan meals that build on one another and provide leftovers for lunches and second meals.

Tip #3 - Use a food waste disposer

With even moderate use, food waste disposers are proven to reduce the amount of food waste in your trash by up to 30%. Using a disposal keeps stinky food scraps out of your trash and reduces harmful bacteria – all while diverting food waste from the landfill.

Tip #4 - Grind more than you would think

Today's food waste disposers enable you to grind more types of food waste than you may realize. Chicken bones, fruit pits and fibrous fruit and vegetable skins are all safe with proper usage.

Benefits of using a disposer:

- Convenient
- Hygienic
- Heavy duty induction motor
- Quietest on the market
- Reduces odours in your kitchen
- Reduces pests in your home
- Reduces waste going into the bin
- Reduced food going to landfills
- Safe on septic tanks

Safe On Septic

You'll find an InSinkEerator food waste disposer in over 6 million American households with a septic tank. InSinkEerator Food waste disposers have always been safe for properly sized septic systems. For example, if your system is sized for a dishwasher or clothes washer, it can handle a disposer. A disposer uses only about as much water per day as one flush of a toilet. No fuss, no mess, no problem, and no reason to deny yourself the convenience and hygiene of an InSinkEerator food waste disposer



FOOD WASTE DISPOSERS



InSinkErator disposers can grind almost any food waste, however there are some things you should not put down the plug hole in general.

✓ Do dispose of:



✗ Do NOT dispose of:



Quiet, clean, safe & extremely convenient

As the inventor of the food waste disposer, InSinkErator has developed and perfected through the years innovative models using advanced technology to suit today's needs. The world-leading brand brings you a responsible answer to the growing problem of food waste.

These 'must have' sink appliances hygienically and safely dispose of food waste at the touch of a button. No more mess, smelly bins, insects or bacteria.

Say goodbye to overflowing bins

Food waste decomposes in bins, resulting in an unhygienic cocktail of the week's waste. It's not only unpleasant but if it ends up in landfill it's methane emissions are extremely bad for the environment.

Using an InSinkErator disposer not only reduces the amount of waste in your bins and removes the bacteria and smells from rotting food. It's also a responsible choice, allowing the capture of value from your food scraps at the wastewater plant.

As easy as 1, 2, 3

There are three simple steps to using InSinkErator waste disposers:



1 Turn cold water tap on



2 Press button



3 Push food waste into sink

EASY TO INSTALL
EASY TO USE
EASY ON THE EYE



From large family homes to individuals living alone, we have a practical and convenient solution for everyone.

Choose the right model for you

EVOLUTION RANGE

EVOLUTION 200



Suitable for

Large and busy households and cooking enthusiasts

EVOLUTION 100



Large households and growing families

M SERIES

MODEL 66



Larger households

MODEL 56



Small to medium households



MultiGrind	x3	x2	x1	x1
Sound Reduction technology	Ultra-Quiet	Quieter	Quiet	Quiet
Built-in Air Switch	✓	✓	✓	✓
Power Booster Circuit	✓	✗	✗	✗
Auto Reverse	✓	✓	✗	✗
Sink Stopper	Stainless Steel Strainer Basket	Stainless Steel Strainer Basket	1-Piece Stainless Steel	Plastic
Easy Clean Baffle	Antimicrobial, Removable	Antimicrobial, Removable	Removable	Removable
Grind Chamber Capacity	1180ml	1005ml	980ml	980ml
Horsepower	0.75 HP	0.75 HP	0.75 HP	0.55 HP

DIMENSIONS

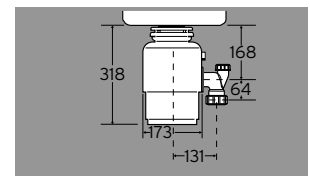
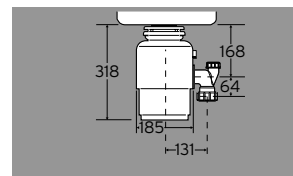
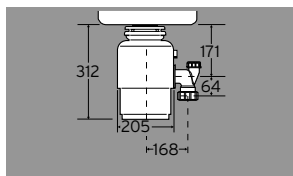
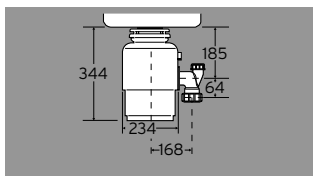

WHAT CAN I PUT DOWN THE FOOD WASTE DISPOSAL?

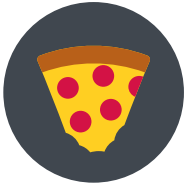

OLD FOOD IN THE FRIDGE

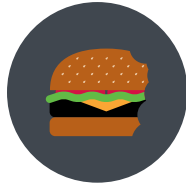

UNEATEN FAST FOOD



VEGGIES/ PEELS



SMALL BONES



LEFTOVERS



ANY NON-FOOD ITEMS



GREASE



OIL



VIDEO: What can be disposed of?



Don't live with food waste
The InSinkErator Food Waste Disposer is the ultimate piece of technology for anyone who loves a clean kitchen.



See for yourself



Food Waste Disposer: Technical



How A Disposer Works



Instillation video



Common Myth:
Septic System



3D Grind Zone Test



Food Scraps Through Your
Plumbing



What Food Can Be
Disposed Of

Food Waste Disposer: A Day In The Life



Kitchen Better: Landfills



Suit Up



Fearless



Cheesecake



Soundproof:
for a quieter kitchen



Soundproof:
Kitchen waterfall



Thelma the pig



All Up In Your Plate

Instant Steaming Hot & Filtered Water

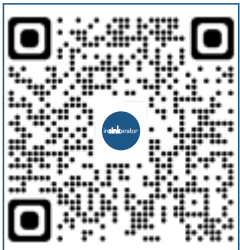

More Family Time



The Morning Mom

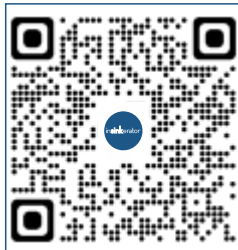

Stress-Free Party



Hot Water Hacks

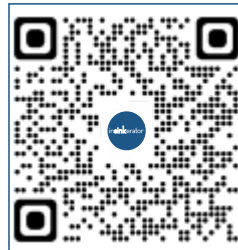

Hot water Tap Installation



Hot Tap Time Machine



GOING GREEN IN THE HOME: HOW FOOD WASTE DISPOSERS CAN PLAY A ROLE

Each year South Africa generates millions of tons of waste – more than 50% of this waste is in the form of food waste. Food waste is the single largest component of municipal solid waste sent to landfills. Once there, it quickly decomposes and produces methane, an environmentally harmful greenhouse gas at least 21 times more potent than carbon dioxide. Landfills are considered the third largest sources of methane in the world.

Food waste disposers keep the kitchen clean, reduce the prevalence of insects, pests and germs. Although disposers help reduce foul odour in the kitchen and improve the convenience and ease of food waste disposal, they are still not a common household product in South Africa.

What is keeping most South African homes from installing a disposer?
There are several common myths that may be holding people back.

FOOD WASTE DISPOSER MYTHS

Myth: Food waste disposers will clog sewerage pipes.

Fact: Modern disposers grind food waste into very fine particles. Also, food waste is essentially the same density as water, so properly used disposers allow plumbing to efficiently transport particles to the wastewater treatment plant. Fats, oils, and grease can create soap-like deposits in sewers, a phenomenon seen around the world, however these deposits occur in locations where disposers are virtually non-existent, demonstrating the problem is not directly associated with their use. InSinkErator recommends that people never pour grease or fat into their disposer, kitchen sink, drain or toilet.

Myth: Food waste disposers use a lot of water and electricity.

Fact: Although operating a food waste disposer does involve running water and using electricity, the environmental impact is minimal. Disposers use only about one percent or less of a household's total water consumption (about as much water per day as one flush of a toilet) and the special induction motor uses very little electricity. A review of ten studies found that water consumption for food waste disposers is less than five (5) litres per household each day. The five litres per household conclusion was the typical finding from five of the studies. The other five studies concluded that water use decreased where disposers are used, or no statistically significant difference in water consumption could be associated with their use.

Myth: You need a double bowl sink to have a food waste disposer installed.

Fact: A food waste disposer can be installed with both a single bowl sink or a double bowl sink, this is a personal preference.

Myth: Food waste disposers have blades and are dangerous to use.

Fact: InSinkErator food waste disposers do not have blades. Instead they have small lugs fixed to a grinding plate that act like hammers breaking down the food whilst spinning. Once small enough, food waste particles pass through small holes in a stationary grind ring, out of the disposer and into the sewerage system.

Myth: Using a food waste disposer means that you can't compost food.

Fact: InSinkErator food waste disposers are complementary to home composting systems. Food types such as meat, dairy and citrus which are not compostable can be placed down the food waste disposer and ultimately kept out of landfills.

Myth: Food waste disposers can't be used on a septic tank.

Fact: InSinkErator food waste disposers are compatible with properly sized and maintained septic systems. For example, if your system is sized for a dishwasher or washing machine, it can handle a disposer. After all, a disposer uses only about as much water per day as one flush of a toilet.

Myth: Food waste disposers are noisy

Fact: InSinkErator Sound Limiter insulation and Anti-vibration mount® technology mean Evolution disposer models can operate with very little noise versus a standard disposer. We also recommend installing a good quality sink with your food waste disposer, which can eliminate vibration and noise.

Myth: Certain food waste items can't go down a disposer.

Fact: The truth is that most food can go down a disposer. High performance models can handle virtually any food waste, including bones and fibrous materials like celery.



Food Waste Disposers

Evolution 200

The perfect food waste solution for large and busy households.

- 60% Quieter than standard models
- 3-Stage grind technology
- Auto-reverse grinding action
- High-torque Dura-Drive™ induction motor
- Built-in air switch
- Stainless steel grind elements
- Stainless steel grind chamber
- Overload protection
- 1,180ml Grind chamber capacity



Type/Option/Version	Colour and specification	Product Code	Matching Accessory
---------------------	--------------------------	--------------	--------------------

400 - 900mm cabinet size

	Stainless Steel/ grey Continuous feed	IN78127T		Air switch cover, matt black INS73274C
	Basket waste <i>Included</i>	INS75265		Air switch cover, satin nickle INS73274
	Air switch <i>Included</i>	INS75430B		Air switch cover, brushed bronze INS73274L
	Jam Buster wrench <i>Included</i>	INS08305D		Sink flange, matt black INS75090D
	Evolution baffle <i>Included</i>	INS74653D		Sink flange, brushed bronze INS77677
	Sink flange <i>Included</i>	INS70129D		Stopper, matt black INS75094D
	Quick Lock® mount <i>Included</i>	INS72376D		Stopper, brushed bronze INS77681

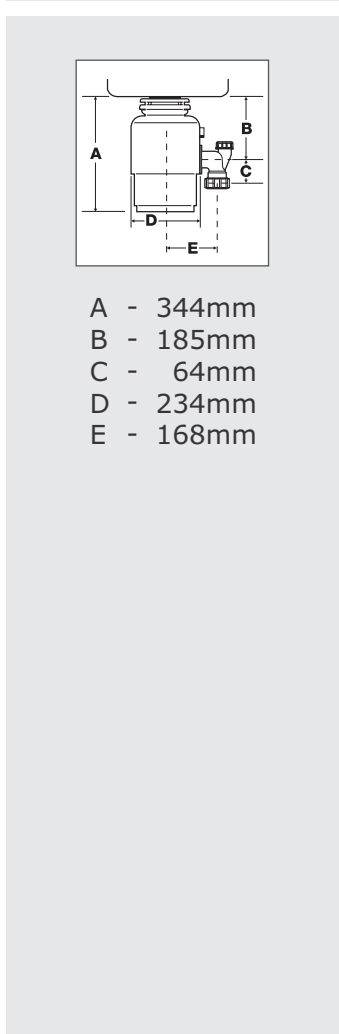

Optional accessory

MySINKspace

Overflow connector INSOFCON	Etagon 8, Black BL00525893	Carena-S, Black BL00526173	HC3300 Hot tap IN44320+ IN45094	Tandem 28L Waste Bin HA3666911

Scope of supply

- Waste disposer
- Basket waste
- Quick-Lock® mounting assembly
- Sound baffle
- Sink flange
- Air switch
- Jam buster wrench
- Type M plug
- Care & use booklet



Food Waste Disposers

Evolution 100

The perfect food waste solution for large households.

- 40% Quieter than standard models
- 2-Stage grind technology
- Auto-reverse grinding action
- High-torque Dura-Drive™ induction motor
- Built-in air switch
- Stainless steel grind elements
- Stainless steel grind chamber
- Overload protection
- 1,005ml Grind chamber capacity



Type/Option/Version	Colour and specification	Product Code	Matching Accessory
---------------------	--------------------------	--------------	--------------------

400 - 900mm cabinet size

	Black enamel grey Continuous feed	IN78125T		Air switch cover, matt black INS73274C
	Basket waste <i>Included</i>	INS75265		Air switch cover, satin nickle INS73274
	Air switch <i>Included</i>	INS75430B		Air switch cover, brushed bronze INS73274L
	Jam Buster wrench <i>Included</i>	INS08305D		Sink flange, matt black INS75090D
	Evolution baffle <i>Included</i>	INS74653D		Sink flange, brushed bronze INS77677
	Sink flange <i>Included</i>	INS70129D		Stopper, matt black INS75094D
	Quick Lock® mount <i>Included</i>	INS72376D		Stopper, brushed bronze INS77681

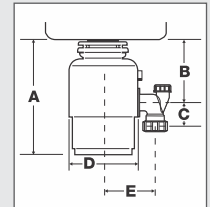

- A - 312mm
- B - 171mm
- C - 64mm
- D - 205mm
- E - 168mm

Optional accessory

MySINKspace



Overflow connector
INSOFCON



Etagon 700-U
BL00525891



Carena-S, Black
BL00526173



HC3300 Hot tap
IN44320+ IN45094



Tandem 28L Waste Bin
HA3666911

Scope of supply

- Waste disposer
- Basket waste
- Quick-Lock® mounting assembly
- Sound baffle
- Sink flange
- Air switch
- Jam buster wrench
- Type M plug
- Care & use booklet

Food Waste Disposers















Model 66

Domestic food waste disposal for large households.

- Single stage grind technology
- High-torque Dura-Drive™ induction motor
- Built-in air switch
- Stainless steel grind elements
- Overload protection
- 980ml Grind chamber capacity



400 - 900mm cabinet size

Type/Option/Version	Colour and specification	Product Code	Matching Accessory
	Black Continuous feed	IN77971T	 Air switch cover, matt black INS73274C
	Steel stopper <i>Included</i>	INS08300D	 Air switch cover, satin nickel INS73274
	Air switch <i>Included</i>	INS75430B	 Air switch cover, brushed bronze INS73274L
	Jam Buster wrench <i>Included</i>	INS08305D	 Sink flange, matt black INS75090D
	Standard baffle <i>Included</i>	INS74653D	 Sink flange, brushed bronze INS77677
	Sink flange <i>Included</i>	INS70129D	 Stopper, matt black INS75094D
	Quick Lock® mount <i>Included</i>	INS72376D	 Stopper, brushed bronze INS77681

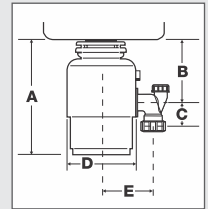

- A - 318mm
- B - 168mm
- C - 64mm
- D - 185mm
- E - 131mm

Optional accessory

MySINKspace



Overflow connector
INSOFCON



Etagon 500-U
BL00521841



Carena-S, Chrome
BL00525089



HC3300 Hot tap
IN44320+ IN45094



Tandem 15/15
HA3650101

Scope of supply

- Waste disposer
- Quick-Lock® mounting assembly
- Stainless Steel stopper
- Sound baffle
- Sink flange
- Air switch
- Jam buster wrench
- Type M plug
- Care & use booklet

Food Waste Disposers

Model 56

Domestic food waste disposal for small to medium households.

- Single stage grind technology
- High-torque Dura-Drive™ induction motor
- Built-in air switch
- Stainless steel grind elements
- Overload protection
- 980ml Grind chamber capacity



Type/Option/Version	Colour and specification	Product Code	Matching Accessory
---------------------	--------------------------	--------------	--------------------

400 - 900mm cabinet size

	Black Continuous feed	IN77970T		Air switch cover, matt black INS73274C
	Plastic stopper <i>Included</i>	INS08306D		Air switch cover, satin nickle INS73274
	Air switch <i>Included</i>	INS75430B		Air switch cover, brushed bronze INS73274L
	Jam Buster wrench <i>Included</i>	INS08305D		Sink flange, matt black INS75090D
	Standard baffle <i>Included</i>	INS74653D		Sink flange, brushed bronze INS77677
	Sink flange <i>Included</i>	INS70129D		Stopper, matt black INS75094D
	Quick Lock® mount <i>Included</i>	INS72376D		Stopper, brushed bronze INS77681

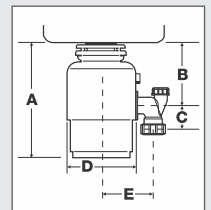

- A - 318mm
- B - 168mm
- C - 64mm
- D - 173mm
- E - 131mm

Optional accessory

MySINKspace



Overflow connector
INSOFCON



Supra 340/340-U
BL00519716



Mida mixer, Chrome
BL00525832



HC1100 Hot tap
IN44318+ IN45094



Tandem 15/15
HA3650101

Scope of supply

- Waste disposer
- Quick-Lock® mounting assembly
- Plastic stopper
- Sound baffle
- Sink flange
- Air switch
- Jam buster wrench
- Type M plug
- Care & use booklet

Installation is easy!

Improve your kitchen.
Make life easier.



in sink erator®

Whether your requirement is for a completely new kitchen, or planned as part of a kitchen upgrade, InSinkErator food waste disposers and steaming hot taps are equally easy to install.

Retro-fitting is a great way to upgrade and improve your kitchen. Improving the functionality will add value too.

Installing food waste disposers



InSinkErator food waste disposers fit neatly under standard sinks, connecting to standard plumbing with an electrical connection required. A good plumber will have no problem installing an InSinkErator food waste disposer.

To operate a food waste disposer, simply:

- Turn on your cold water tap
- Press the air switch button
- Push any food waste into the sink plug hole
- Press the air switch button to turn off
- Turn off your cold tap

Installing steaming hot taps



Just as easily retro-fitted as it is integrated into a brand new kitchen design, the choice of an InSinkErator steaming hot water tap will provide you with an easy-to-fit, effortless update to your home



Instant convenience.

Instantly dispense near-boiling water right at your kitchen sink. Whether you're cooking, cleaning without harsh chemicals, or preparing hot drinks, InSinkErator makes hot water happen instantly.

Contemporary 1100

AT HOME ANYWHERE.

Thanks to its modern flair and blended design, Contemporary 1100 infuses the kitchen with added energy and instant convenience. Sleek, elegant and engaging, this hot water dispenser is at home in any kitchen. Pair it with faucets that feature universal design lines and finishes.

Available in:  HOT/COLD



Modern 3300

SOPHISTICATED SIMPLICITY.

Sleek, bold and edgy, Modern 3300 is the perfect hot water dispenser for homeowners seeking modern minimalism in their kitchen settings. Designed with clean lines and contemporary styling, Modern 3300 blends household efficiency with a form that competes with fine art.

Available in:  HOT/COLD



Filtered near-boiling water from Neotank



The compact and innovative NeoTank[®] delivers filtered near boiling water for hot drinks and slashes your cooking times with steaming water for vegetables and pasta dishes. This ingenious unit also comes with an optional connector that allows you to filter your cold water as well, giving you great tasting filtered water straight from your tap.

- NeoTank[®] is only about the size of a toaster, making it easy to install on the back wall under your kitchen bench with minimum fuss.
- The 2.5-litre capacity is easily sufficient for most kitchen tasks.
- Reduces the cost of heating water, saving you energy costs.
- Finger-tip control with a touch-panel display for precise temperature adjustment.
- Able to run on a standard electrical circuit drawing 5.6AMPs with an element size of 1.3KW.
- Quiet, energy-efficient operation.
- Easy installation with tool-free connections and dry-start protection.
- 1-year limited warranty.



Digital touch screen easy temperature control from 87°C to 98°C

Heating element for rapid recovery able to run on a standard electrical circuit

The energy-efficient way to make a cuppa

A poorly managed kettle can waste an incredible amount of energy...heating...re-heating...re-heating again. Each time heating more water than you actually need.

The NeoTank uses less energy than a 40W light bulb in stand-by mode and 20% less energy than a kettle when using 10 cups of near-boiling water per day.



Instant Hot Water Dispensers & Filter Taps

HC3300

A blend of efficiency and style creates this functional near-boiling water dispenser.

- Streamlined design with single-handle activation
- Near-boiling (98°C) filtered water
- Approximately 100 cups per hour
- Ambient temperature filtered water
- Integrated safety activation lever
- Blends perfectly into almost any kitchen
- Available in classic chrome

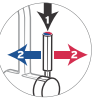

Type/Option/Version	Colour and specification	Product Code	Matching Accessory
---------------------	--------------------------	--------------	--------------------



Chrome
Multi-function

IN44320



Hot water NeoTank set
IN45094

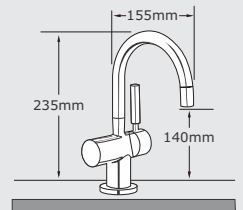

Spares

MySINKspace



Replacement filter
INS44634B



EVO 200 disposer
IN78127T



Stepfix ladder
HA4410001



Carena-S, Chrome
BL00525089



Etagon 6, Black
BL00525890

Scope of supply

- Hot water tap
- Flexible hoses
- Mounting accessories
- Installation guide









Instant Hot Water Dispensers & Filter Taps

HC1100

A blend of efficiency and style creates this functional near-boiling water dispenser.

- Streamlined design
- Near-boiling (98°C) filtered water
- Approximately 100 cups per hour
- Ambient temperature filtered water
- Integrated safety activation lever
- Blends perfectly into almost any kitchen
- Available in four colour finishes



Type/Option/Version	Colour and specification	Product Code	Matching Accessory
	Chrome Multi-function	IN44318	 Hot water NeoTank set IN45094
	Brushed Steel Multi-function	IN44318B	 Hot water NeoTank set IN45094
	Matt Black Multi-function	IN44252Y	 Hot water NeoTank set IN45094
	Brushed Bronze Multi-function	IN44252AK	 Hot water NeoTank set IN45094

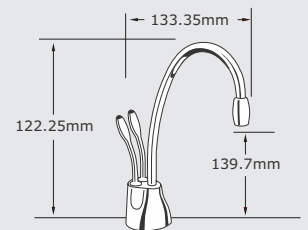

Spares

MySINKspace

 Replacement filter INS44634B	 EVO 200 disposer IN78127T	 Stepfix ladder HA4410001	 Linus-S, Chrome BL00519368	 Etagon 6, Black BL00525890
--	---	--	--	---

Scope of supply

Hot water tap
Flexible hoses
Mounting accessories
Installation guide

Instant Hot Water Dispensers & Filter Taps

NeoTank™

The Stainless Steel Tank dispenses filtered steaming hot water instantly.

- 2,5 Litre Stainless Steel tank
- Easy to adjust electronic temperature (88°C-98°C)
- Maintains precise temperature setting $\pm 0,5^\circ\text{C}$
- Tool-free tank connections
- Dry start protection



400 - 900mm cabinet size

Type/Option/Version	Colour and specification	Product Code	Matching Accessory
---------------------	--------------------------	--------------	--------------------



White casing
Stainless Steel tank
2,5l Capacity

IN45094



HC3300
Multi-function
IN44320



Chrome
Multi-function
IN44318



Brushed Steel
Multi-function
IN44318B



Matt Black
Multi-function
IN44252Y



Brushed Bronze
Multi-function
IN44252AK

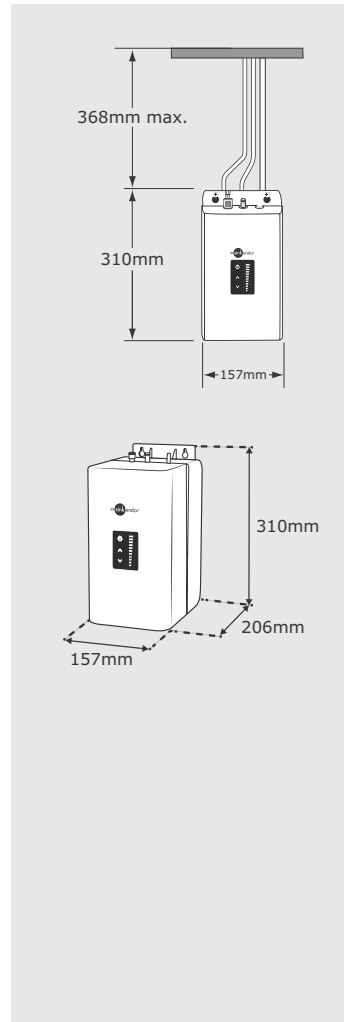

Spares

MySINKspace



Replacement filter
INS44634B



EVO 200 Waste disposer
IN78127T



Tandem 28L Waste Bin
HA3666911



Linus-S, Black/Chrome
BL00526150/BL00519368



Etagon 500
BL00525887

Scope of supply

- Hot water tank
- Water filter
- Mounting accessories
- Connection hoses
- Care & use booklet

THE NEWEST Lifehack

INSTANT HOT WATER. INSTANTLY GRATIFYING.



Instant hot water on demand. You'll wonder how you ever lived without it.



Life Hacks

- Remove Stains
- Easily Remove Labels
- Loosen New Jars
- Remove Red Wine Stains
- Make French Press Coffee
- Soften Pet Food
- Remove Candle Wax
- Rinse Shake Bottles
- Clean Toothbrushes
- Create Aromatherapy Steam
- Prepare a Hot Compress
- Fill Hot Water Bottle



Cleaning Hacks

- Clean Without Chemicals
- Clean Refrigerator Shelves
- Clean Utensils
- Clean Microwave Tray
- Remove Grass Stains
- Clean Pet Bowls
- Rinse Crusty Plates
- Clean Vases
- Remove Tea/Coffee residue
- Clean Eyeglasses
- Pre-Warm Tea/Coffee Cups



Cooking Hacks

- Kick-Start Boiling
- Remove Baking Residue
- Thaw Frozen Vegetables
- Thaw Frozen Foods
- Warm Knives for Cutting
- Cook Instant Rice
- Rinse PB&J Knife
- Pre-Boil Sausage
- Make Ramen Noodles
- Prepare Instant Oatmeal
- Heat Syrup
- Cook Instant Hashbrowns



Parenting Hacks

- Clean Baby Bibs
- Warm Baby Bottles
- Clean Baby Toys
- Clean Aquariums
- Clean Paint Brushes
- Clean Medicine Droppers
- Make Hot Cocoa
- Clean Lunch Boxes
- Make Gelatin
- Form Sports Mouth Guards
- Warm Chocolate Syrup



Whilst Larson has used its best endeavours to ensure that the information provided in this catalogue - including (but not limited to) technical specifications, measurements and colours - are accurate and up to date at the time of issue, does not warrant that it is correct or complete. We reserve the right to make corrections and changes without notification and unless otherwise stated and agreed upon in writing, Larson makes no warranties of any kind, express or implied, that goods sold are suitable for any particular purpose or application under any specific condition. It is recommended that every item should be thoroughly tested by the purchaser to determine performance suitability before use of goods.

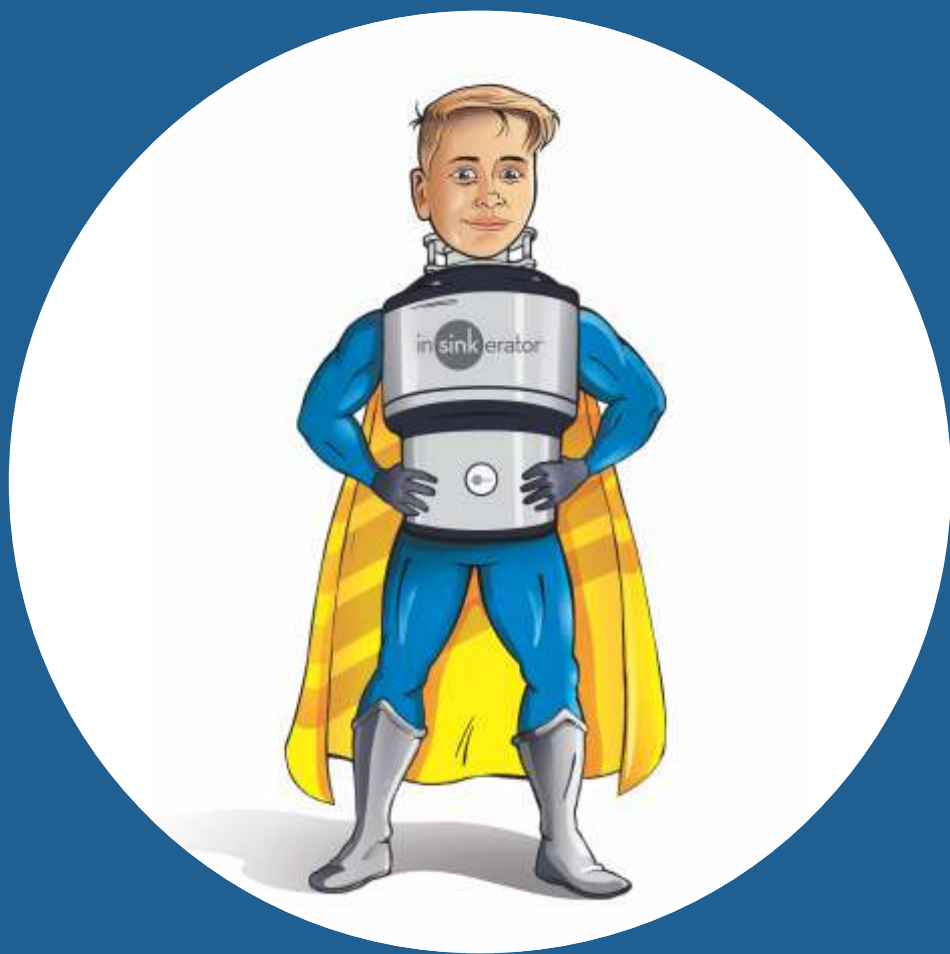

www.larson.co.za